

# Transforming VIEWS

nextview  
the vision...



# SINCE 2004

Everything Next Tech Group creates is designed with you in mind and Nextview Technology follows the same footprint as being an integral part of this multidisciplinary group. Today, Nextview Technology is India's leading electronic manufacturer of Televisions, Air Purifiers, and Air Conditioners who is pushing the boundaries of innovation with each passing day. Being the founding father, Mr. Nishith Mirani nourished the brand with his expertise and made Nextview Technology a successful venture which aims to deliver high quality, cutting-edge and affordable electrical products for the home that offer an unparalleled experience to customers.

For decades, Nextview has been at the forefront in the segment of consumer electronics by delivering advanced solutions of international standards. By working tirelessly on the research and development, Nextview Technology is raising the bar across our industry, and proudly pioneering new innovations. The efficient coordination of our support team and strong pan India network of branch offices, distributors, dealers, and service centers keep the customer's needs on the top and satisfy them beyond expectation. A strong promoter of the Government of India's Make-in-India initiative, Nextview manufacturing has a state of art plant in India and takes pride in being a 'Made in India' solution.

Nextview ceaselessly draws inspiration from people's journey and strives continuously to develop a better experience with state-of-the-art products. We are determined to offer a wide range of 'Best-in-Class' TV, AC and Air Purifier products & solutions that redefine the way of living across generations.



## VISION

Nextview Technology aspires to be a leader in developing groundbreaking innovations for home electronic products. We are committed to providing solutions that help customers to live better. We wish to deliver values, benefits, promises and personality through Nextview Products which simplify your lives and provide an unmatched customer experience.



## MISSION

Nextview is on a mission to create excellent home solutions by harnessing innovations. Within the framework of law, and with pride in ethical values, we wish to benefit our employees and society at large through responsible business practice.

## VALUES



Customer Satisfaction



Integrity



Teamwork



Trust



Quality



Consistency



Long Time Relationship



**2 YEAR TRIPLE PROTECTION WARRANTY**

**nextview**  
the vision...



# PROUD CERTIFICATION

**RoHS CERTIFICATE**

**Certificate of Compliance**

This is to Certify that the following designated products :  
Smart Led TV, Air Condition, Cables, Air Purifier and Trading of Consumer Electronic Products

This certificate of compliance is based on the technical file of above mention products

**Manufactured By :**  
**NEXTVIEW TECHNOLOGIES (INDIA) PRIVATE LIMITED**  
T F 3, Shakti Square, Opp. Management Enclave, Vastrapur, Ahmedabad - 380015, Gujarat, India.

*Application of Council Directive on the Restriction of the use of certain Hazardous Substances in Electrical and Electronic Equipment 2011/65/EU*

CERTIFICATE No. : 22ZGA9669R

ISSUED DATE : 15/04/2022      1st SURVEILLANCE : 14/04/2023  
EXPIRE DATE : 14/04/2025      2nd SURVEILLANCE : 14/04/2024

**UKAC** **RoHS compliant**

**Authorized Signatory**  
INTERNATIONAL QUALITY CERTIFICATION SERVICES UK LTD  
375, Bath Street, Glasgow G2 4AP, UK.

**CE CERTIFICATION**

**Certificate of Compliance**

This is to Certify that the following designated products :  
Smart Led TV, Air Condition, Cables, Air Purifier and Trading of Consumer Electronic Products

This certificate is based under the following conditions:  
1. It applies only to the above referenced set of products mentioned above. The manufacturer is obligated to assure that all products of the respective model conform to the type assessed by this certificate.  
2. The Certificate validity is conditional to the positive result of the surveillance audits.  
3. The Certificate remains valid until such the manufacturing conditions, the quality systems or relevant regulations are changed for the first time.  
4. After fulfilling the EU legislative requirements, the manufacturer shall affix to each product of the above referenced models, CE Marking according to the following example:

**Manufactured By**  
**NEXTVIEW TECHNOLOGIES (INDIA) PRIVATE LIMITED**  
T F 3, Shakti Square, Opp. Management Enclave, Vastrapur, Ahmedabad - 380015, Gujarat, India.

*Conforms with the Applicable requirements of Low Voltage Directive LVD (2014/35/EU)*

CERTIFICATE No. : 22ZGA9669C

ISSUED DATE : 15/04/2022      1st SURVEILLANCE : 14/04/2023  
EXPIRE DATE : 14/04/2025      2nd SURVEILLANCE : 14/04/2024

**UKAC** **CE**

**Authorized Signatory**  
INTERNATIONAL QUALITY CERTIFICATION SERVICES UK LTD  
375, Bath Street, Glasgow G2 4AP, UK.

**BQC Bureau of Quality Certification**

**CERTIFICATE OF COMPLIANCE**

WAS evaluated and confirmed to comply with the requirement of  
FCC PART 15B  
NEXTVIEW TECHNOLOGIES (INDIA) PRIVATE LIMITED  
T F 3, Shakti Square, Opp. Management Enclave, Vastrapur, Ahmedabad - 380015, Gujarat, India.

has been assessed and found to be conforming the requirements of the

**FCC**  
Product Descriptions  
Smart Led TV, Air Condition, Cables, Air Purifier and Trading of Consumer Electronic Products

This certificate of compliance is based on the technical file of above mention products

Issued Date : 15/04/2022      1st Surveillance : 14/04/2023  
2nd Surveillance : 14/04/2024  
Expiry Date : 14/04/2025

Certificate No. : BOC/INDO22F59

**BQC FCC CERTIFIED**

**BUREAU OF QUALITY CERTIFICATION UK LTD**  
71-73, Shelton Street, Covent Garden, London, WC2E 8JQ

**QUALITY MANAGEMENT SYSTEM**

**Certificate of Registration**

This is to Certify That The Quality Management System of  
NEXTVIEW TECHNOLOGIES (INDIA) PRIVATE LIMITED  
T F 3, SHAKTI SQUARE, OPP. MANAGEMENT ENCLAVE, VASTRAPUR, AHMEDABAD - 380015, GUJARAT, INDIA.

has been assessed and found to conform to the requirements of

**ISO 9001:2015**  
for the following scope :  
MANUFACTURING, TRADING OF SMART LED TV, AIR CONDITION, CABLES, AIR PURIFIER AND TRADING OF CONSUMER ELECTRONIC PRODUCTS.

Certificate No : 22DQIN56      Issuance Date : 15/04/2022  
Initial Registration Date : 15/04/2022      Date of Expiry : 14/04/2025  
Date of Expiry : 14/04/2025      1st Surve. Due : 15/03/2023      2nd Surve. Due : 15/03/2024

**ROHS Certification Pvt. Ltd.**  
110, New Market Road, Chennai - 600 029

**ENERGY IS LIFE**

**B E E**

**CONSERVE IT!**

BE/NEX/06/00602/22

**Brand** : NEXTVIEW  
**Model No./Year** : NV2FH43S9/2022  
**Equipment Type** : LCD (With LED backlight)  
**Screen Size** : 108 CM

\*Under test Conditions when tested in accordance with relevant Standards. Actual energy consumption will depend on how the equipment is used.

**Annual Energy Consumption (kWh/Year)**

**94.5\***

Label Period: 1st Jan 2019 - 30th June 2022

**POWER SAVINGS GUIDE**

**MORE STARS MORE SAVINGS**

1 2 3 4 5

# NVS24K85S9

## 85" ANDROID SMART 4K LED TV

### ARTISTIC DESIGN

Frameless Design

### ULTIMATE PICTURE QUALITY

3840×2160 | 4k Ultra HD

### SMART FEATURES

- Mobile, Laptop, PC and Tablets Sharing
- Android Support
- Windows, IOS, Android Screen Sharing
- Third Party Hardware & Software Support

### CONNECTIVITY

- 3 HDMI
- 3.0 USB
- LAN & WI-FI, HOTSPOT
- AV IN & AV OUT,
- Coaxial / Optical Out

### MEMORY

- 2 GB RAM
- 16 GB ROM

### SUPER SOUND QUALITY

Surrounding Effect

Framless Design



Voice Control

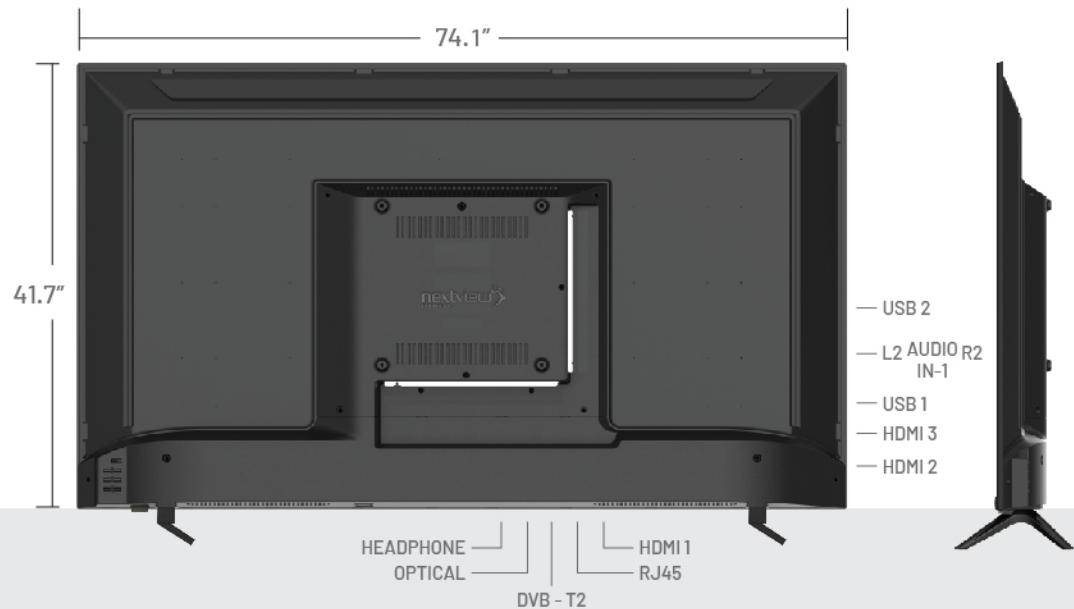

nextview  
the vision...





# NVS24K75S9

FRAMELESS  
DISPLAY

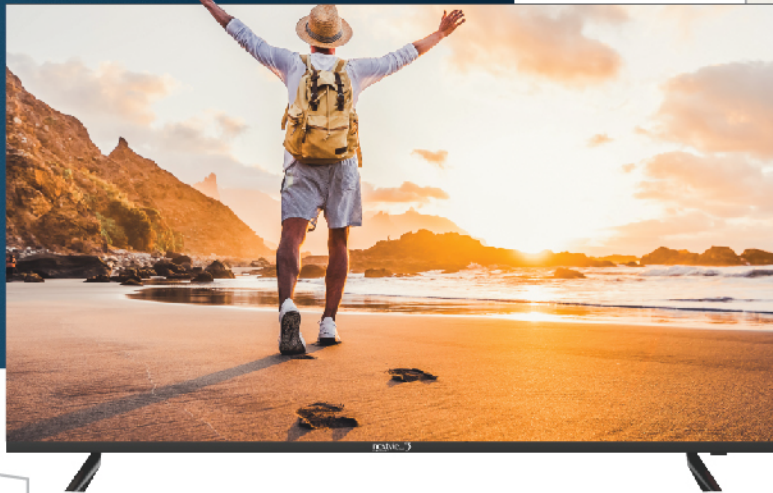

Voice Control

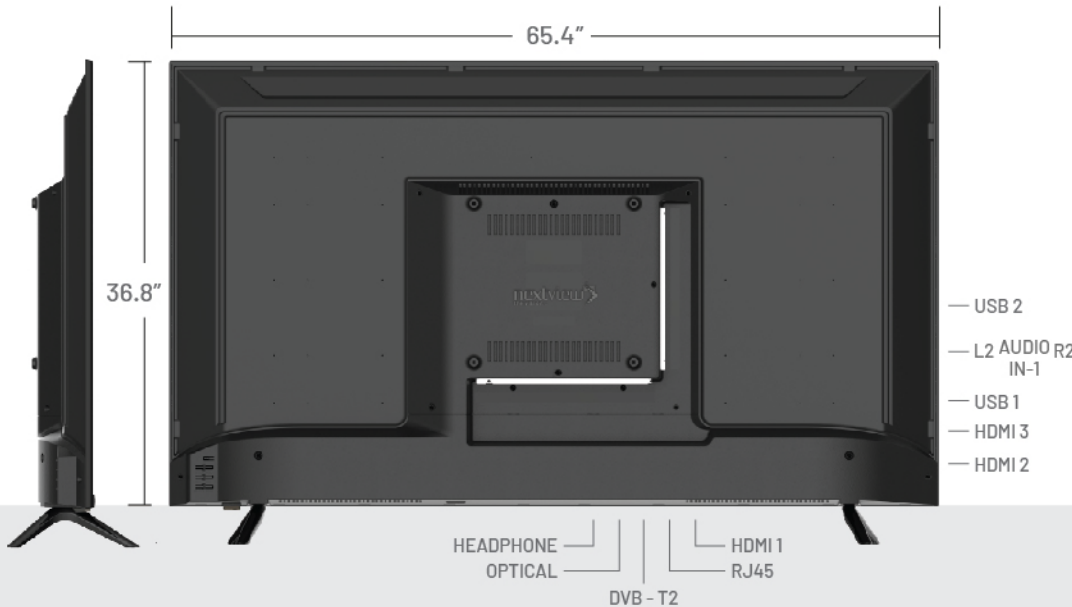

## 75" ANDROID SMART 4K LED TV

### ARTISTIC DESIGN

Frameless Design

### ULTIMATE PICTURE QUALITY

3840×2160 | 4k Ultra HD

### SMART FEATURES

- Mobile, Laptop, PC and Tablets Sharing
- Android Support
- Windows, IOS, Android Screen Sharing
- Third Party Hardware & Software Support

### CONNECTIVITY

- 3 HDMI
- 3.0 USB
- LAN & WI-FI, HOTSPOT
- AV IN & AV OUT,
- Coaxial / Optical Out

### MEMORY

- 2 GB RAM
- 16 GB ROM

### SUPER SOUND QUALITY

Surrounding Effect



**nextview**  
the vision...

# 65" ANDROID SMART 4K LED TV

## ARTISTIC DESIGN

Metallic Border

## ULTIMATE PICTURE QUALITY

3840x2160 | 4k Ultra HD

## SMART FEATURES

- Mobile, Laptop, PC and Tablets Sharing
- Android Support
- Windows, IOS, Android Screen Sharing
- Third Party Hardware & Software Support

## CONNECTIVITY

- 3 HDMI
- 2 USB
- LAN & WI-FI, HOTSPOT
- AV IN & AV OUT,
- Coaxial / Optical Out

## MEMORY

- 2 GB RAM
- 16 GB ROM

## SUPER SOUND QUALITY

Surrounding Effect

# NV24K65S9

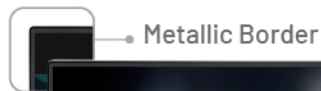

*Voice Control*

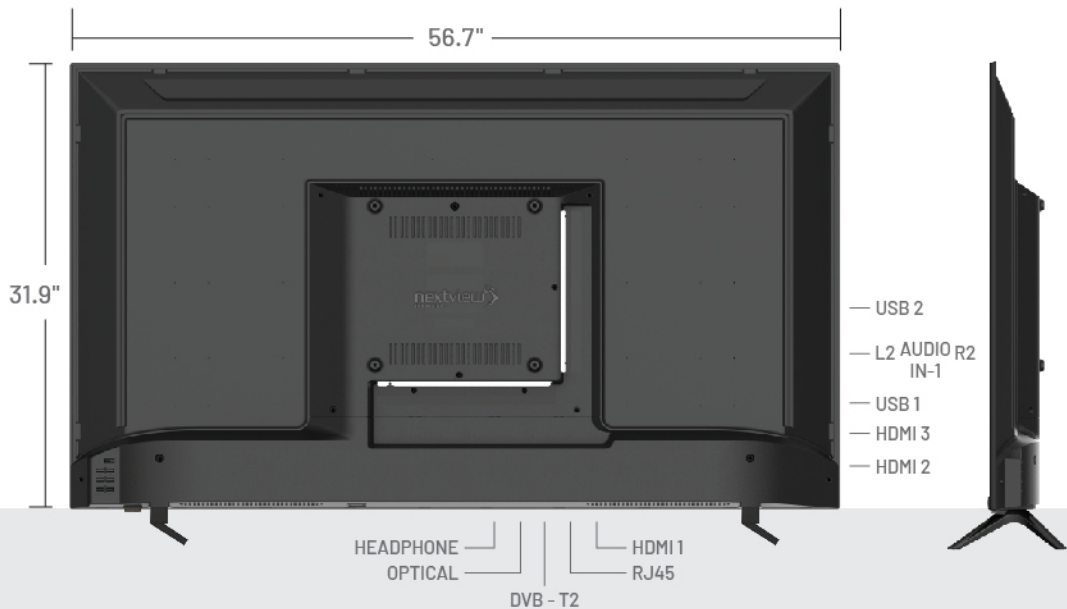

**nextview**  
the vision...





# NV20K55S

Framless Design



Voice Control  
Air Motion



With Inbuilt Sound Bar

48.5"

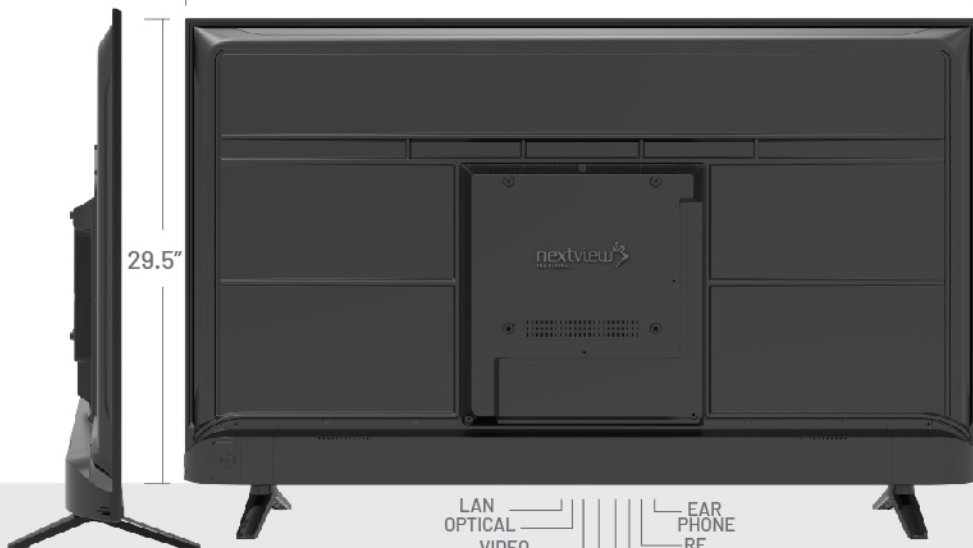

29.5"

USB  
1  
2  
HDMI 3  
1  
2  
3

LAN  
OPTICAL  
VIDEO  
IN-1  
L AUDIO  
IN-1  
R  
VIDEO  
IN-2  
EAR  
PHONE  
RF  
L AUDIO  
IN-1  
R

## 55" ANDROID SMART QLED TV

### ARTISTIC DESIGN

Frameless Slim Panel

### ULTIMATE PICTURE QUALITY

3840×2160 | 4k Ultra HD

### SMART FEATURES

- Cloud Technology
- Voice Control
- Mobile, Laptop, PC and Tablets Sharing
- Android Support
- Windows, IOS, Android Screen Sharing
- Third Party Hardware and Software Support

### CONNECTIVITY

- 3 HDMI
- 3.0 USB
- LAN & WI-FI, HOTSPOT
- AV IN & AV OUT

### MEMORY

- 2 GB RAM
- 16 GB Rom

### SUPER SOUND QUALITY

Inbuilt Soundbar



WI-FI



BLUE  
TOOTH



ANDROID  
TV



HDMI X3



SOUND  
THEATRE



QUAD CORE  
PROCESSOR

nextview  
the vision...

# NV24K55S9

## 55" ANDROID SMART 4K LED TV

### ARTISTIC DESIGN

Bezel Less Slim Panel

### ULTIMATE PICTURE QUALITY

3840×2160 | 4k Ultra HD

### SMART FEATURES

- Cloud Technology
- Mobile, Laptop, PC and Tablets Sharing
- Android Support
- Windows, IOS, Android Screen Sharing
- Third Party Hardware & Software Support

### CONNECTIVITY

- 3 HDMI
- 2 USB
- LAN & WI-FI, HOTSPOT
- AV IN & AV OUT,
- Coaxial / Optical Out

### MEMORY

- 2 GB RAM
- 16 GB ROM

### SUPER SOUND QUALITY

Surrounding Effect



Metal  
Stand



Voice Control  
Air Motion

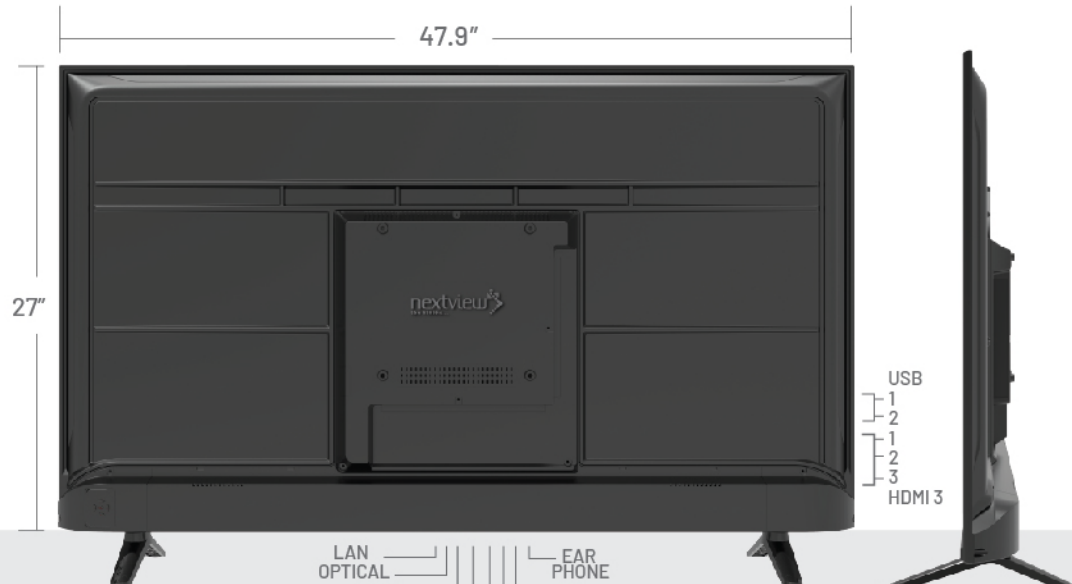

USB  
1  
2  
HDMI 3  
1  
2  
3

LAN  
OPTICAL  
VIDEO  
IN-1  
L AUDIO R  
IN-1

EAR  
PHONE  
RF  
L AUDIO R  
IN-1  
VIDEO  
IN-2



AV IN



USB X2

nextview  
the vision...



WI-FI



BLUE  
TOOTH



ANDROID  
TV



HDMI X3



SOUND  
THEATRE

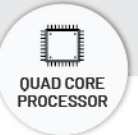

QUAD CORE  
PROCESSOR



# NV24K50S9

FRAMELESS  
DISPLAY



Voice  
Control  
Air Motion

Metal  
Stand



## 50" ANDROID SMART 4K LED TV

### ARTISTIC DESIGN

Frameless Design

### ULTIMATE PICTURE QUALITY

3840×2160 | 4k Ultra HD

### SMART FEATURES

- Cloud Technology
- Mobile, Laptop, PC and Tablets Sharing
- Android Support
- Windows, IOS, Android Screen Sharing
- Third Party Hardware & Software Support

### CONNECTIVITY

- 3 HDMI
- 2 USB
- LAN & WI-FI, HOTSPOT
- AV IN & AV OUT,
- Coaxial / Optical Out

### MEMORY

- 2 GB RAM
- 16 GB ROM

### SUPER SOUND QUALITY

Surrounding Effect

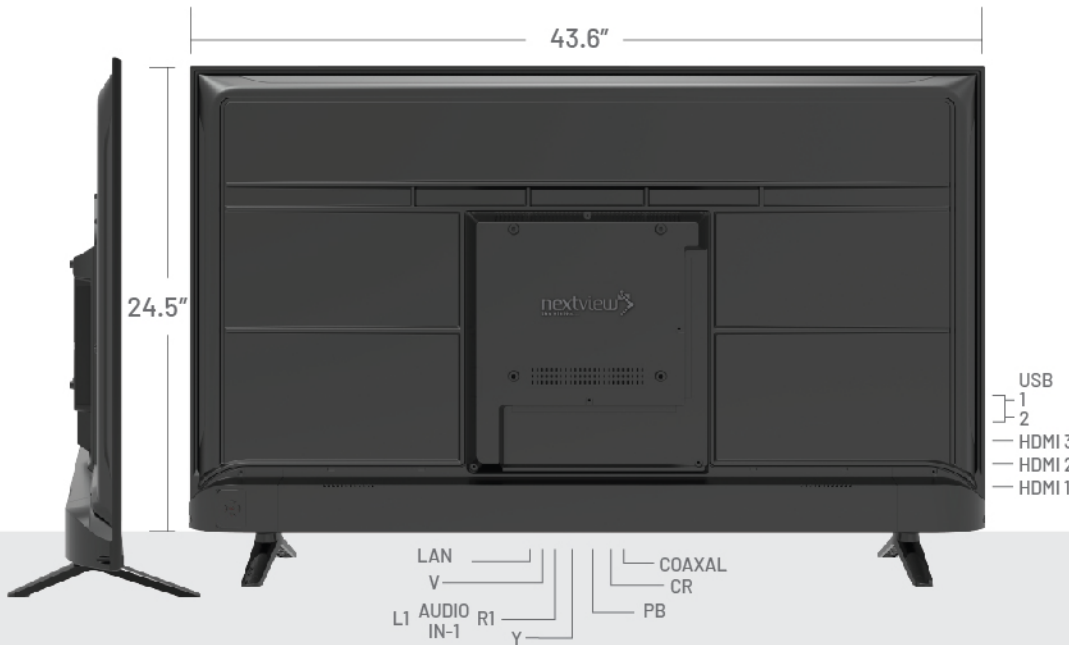

WI-FI



BLUE  
TOOTH



ANDROID  
TV



HDMI X3

SOUND  
THEATRE



QUAD CORE  
PROCESSOR

nextview®  
the vision...

# 43" ANDROID SMART LED TV

## ARTISTIC DESIGN

Bezel Less Display

## ULTIMATE PICTURE QUALITY

1920x1080 | Full HD

## SMART FEATURES

- Cloud Technology
- Mobile, Laptop, PC and Tablets Sharing
- Android Support
- Windows, IOS, Android Screen Sharing
- Third Party Hardware & Software Support

## CONNECTIVITY

- 2 HDMI
- 2 USB
- AV IN & AV OUT
- Audio IN & Audio OUT

## MEMORY / OPTIONAL

- 1 GB RAM / 2 GB
- 8 GB ROM / 16 GB

## SUPER SOUND QUALITY

Surrounding Effect



**nextview**  
the vision...

Framless Design

# NV2FH43S9



Full HD  
1080p



Voice Control  
Air Motion

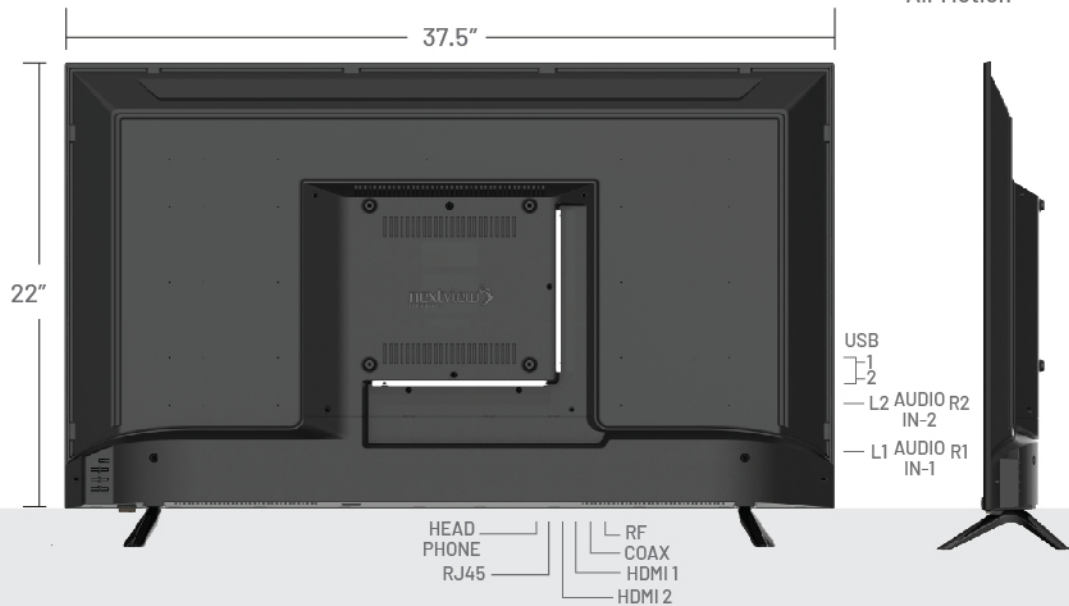



# NV2FH39S9



**24/7**  
Ready For CCTV  
Surveillance

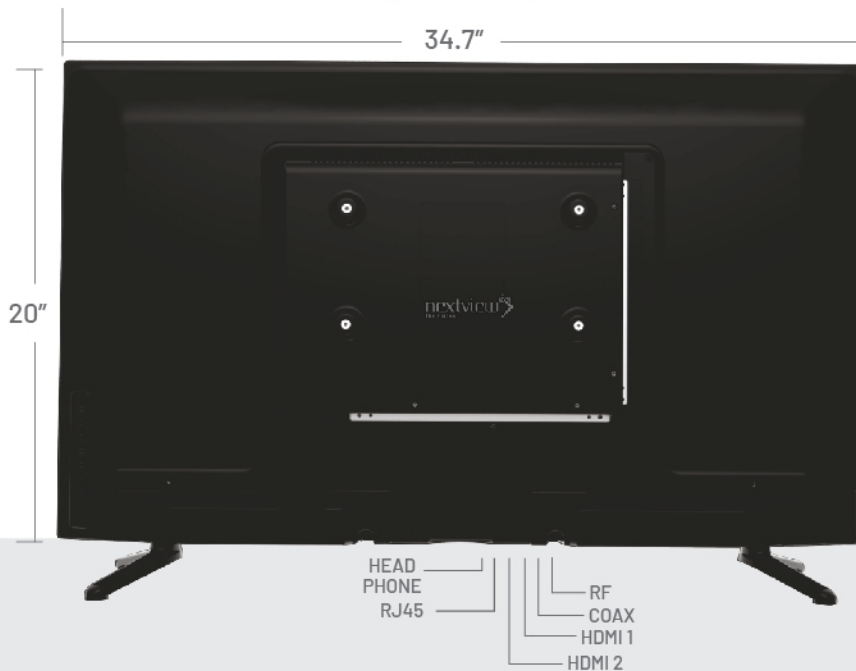

## 39S" ANDROID SMART LED TV

### ARTISTIC DESIGN

Black Border

### ULTIMATE PICTURE QUALITY

1920×1080 | Full HD

### SMART FEATURES

- Cloud Technology
- Mobile, Laptop, PC and Tablets Sharing
- Android Support
- Windows, IOS, Android Screen Sharing
- Third Party Hardware and Software Support

### CONNECTIVITY

- 2 HDMI
- 2 USB
- LAN & WI-FI, HOTSPOT
- AV IN & AV OUT

### MEMORY / OPTIONAL

- 1 GB RAM / 2 GB
- 8 GB ROM / 16 GB

### SUPER SOUND QUALITY

Surrounding Effect



**nextview**  
the vision...

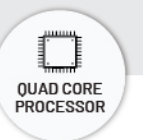

# NV2FH39L

## 39L" LED TV

### ARTISTIC DESIGN

Black Border

### ULTIMATE PICTURE QUALITY

1920×1080 | Full HD

### CONNECTIVITY

- 2 HDMI
- 2 USB
- AV IN & AV OUT
- VGA / RF

### SUPER SOUND QUALITY

Surrounding Effect

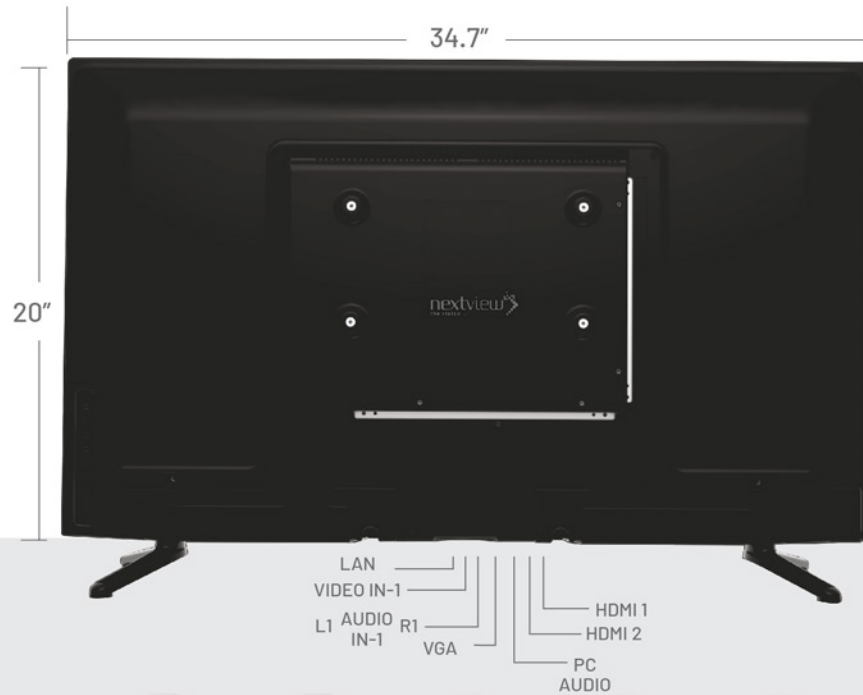

- USB 1
- USB 2
- MICRO SD
- LINE OUT
- COAX OUT
- L2 AUDIO IN-1
- R2
- VIDEO IN-2

**nextview**  
the vision...





# NV2FH32SL9

Framless Design

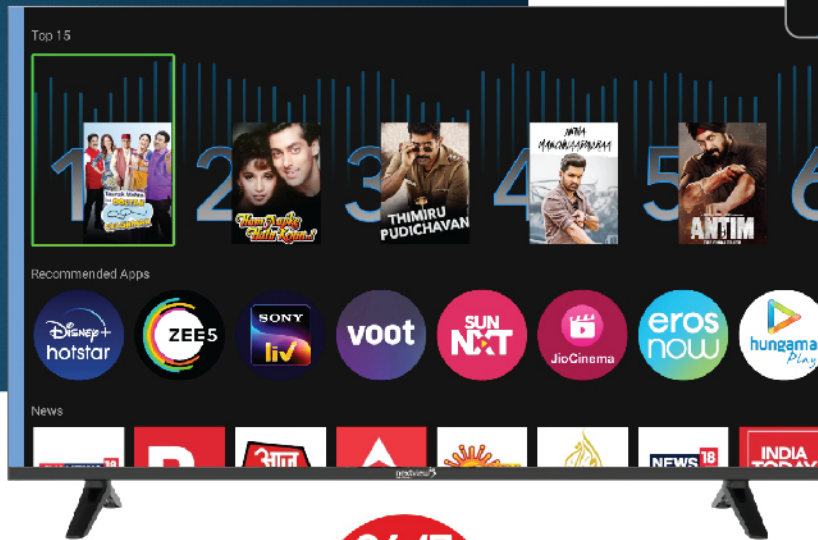

24/7  
Ready For CCTV  
Surveillance

29"

17"



USB  
1  
2  
- L2 AUDIO IN-2  
- L1 AUDIO IN-1

HEAD PHONE  
RJ45  
HDMI 1  
HDMI 2  
RF IN  
COAX

## 32S" ANDROID SMART LED TV

### ARTISTIC DESIGN

Framless Design

### ULTIMATE PICTURE QUALITY

1920×1080 | Full HD

### SMART FEATURES

- Cloud Technology
- Mobile, Laptop, PC and Tablets Sharing
- Android Support
- Windows, IOS, Android Screen Sharing
- Third Party Hardware and Software Support

### CONNECTIVITY

- 2 HDMI
- 2 USB
- Audio IN & Audio OUT
- AV IN & AV OUT

### MEMORY / OPTIONAL

- 1 GB RAM / 2 GB
- 8 GB ROM / 16 GB

### SUPER SOUND QUALITY

Surrounding Effect



USB X2



TRUE  
COLOURS



WI-FI



AV IN



ANDROID  
TV



HDMI 2



SOUND  
THEATRE



QUAD CORE  
PROCESSOR

nextview  
the vision...

# NV2FH32WL

Framless Design

## 32W" LED TV

### ARTISTIC DESIGN

Bezel Less Display

### ULTIMATE PICTURE QUALITY

1920x1080 | Full HD

### CONNECTIVITY

- 2 HDMI
- 2 USB
- Audio IN & Audio OUT
- AV IN & AV OUT
- VGA / RF

### SUPER SOUND QUALITY

Surrounding Effect

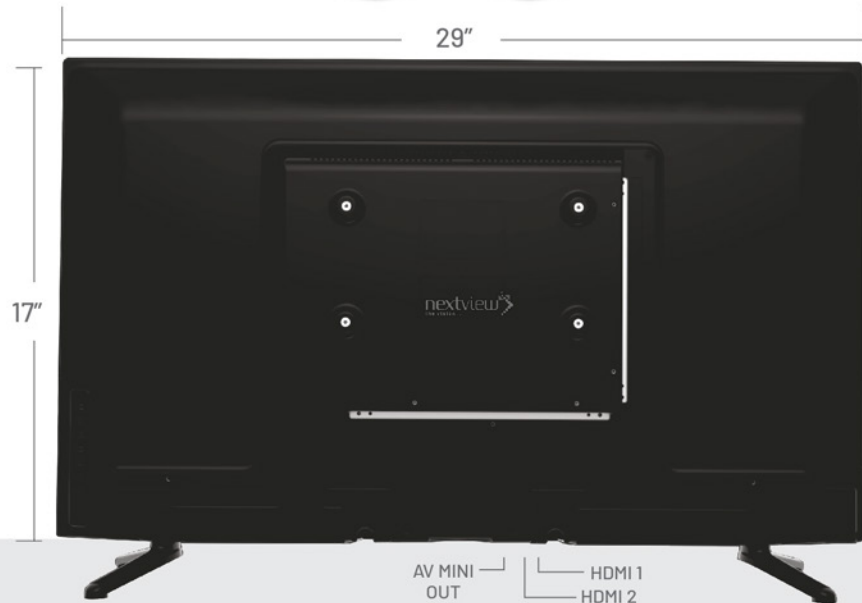

nextview  
the vision...





# NV2FH24S9

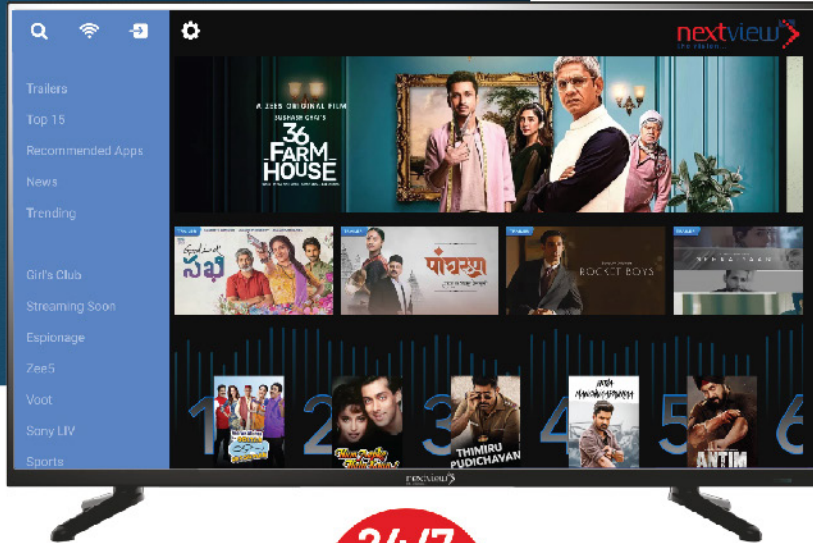

**24/7**  
Ready For CCTV  
Surveillance

22"

11"

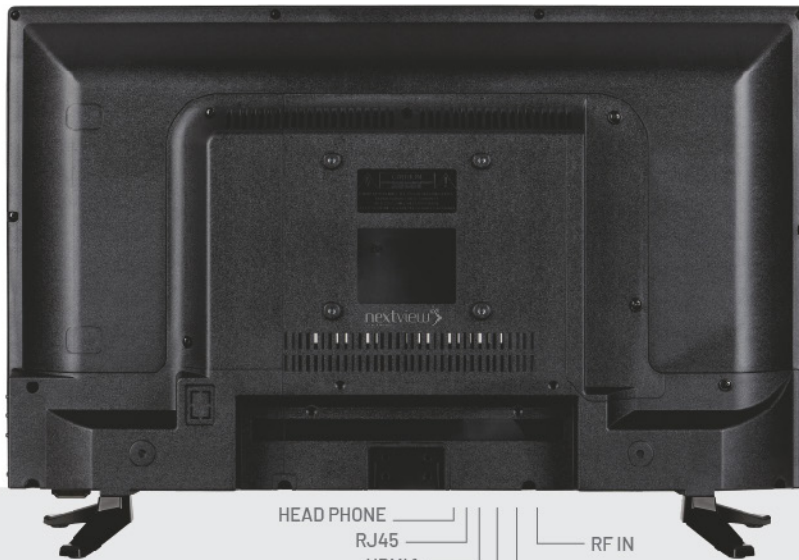

HEAD PHONE  
RJ45  
HDMI 1  
HDMI 2  
RF IN  
COAX

USB  
1  
2  
- L2 AUDIO IN-2  
- L1 AUDIO IN-1

## 24S" ANDROID SMART TV

### ARTISTIC DESIGN

Black Border

### ULTIMATE PICTURE QUALITY

1920×1080 | Full HD

### SMART FEATURES

- Cloud Technology
- Mobile, Laptop, PC and Tablets Sharing
- Android Support
- Windows, IOS, Android Screen Sharing
- Third Party Hardware and Software Support

### CONNECTIVITY

- 2 HDMI
- 2 USB
- LAN & WI-FI, HOTSPOT
- AV IN & AV OUT

### MEMORY / OPTIONAL

- 1 GB RAM / 2 GB
- 8 GB ROM / 16 GB

### SUPER SOUND QUALITY

Stereo Sound

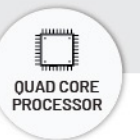

**nextview**  
the vision...

# NV2FH24L

## 24L" LED TV

### ARTISTIC DESIGN

Black Border

### ULTIMATE PICTURE QUALITY

1920×1080 | Full HD

### CONNECTIVITY

- HDMI
- USB
- Audio IN & Audio OUT
- AV IN & AV OUT
- VGA / RF

### SUPER SOUND QUALITY

Stereo Sound

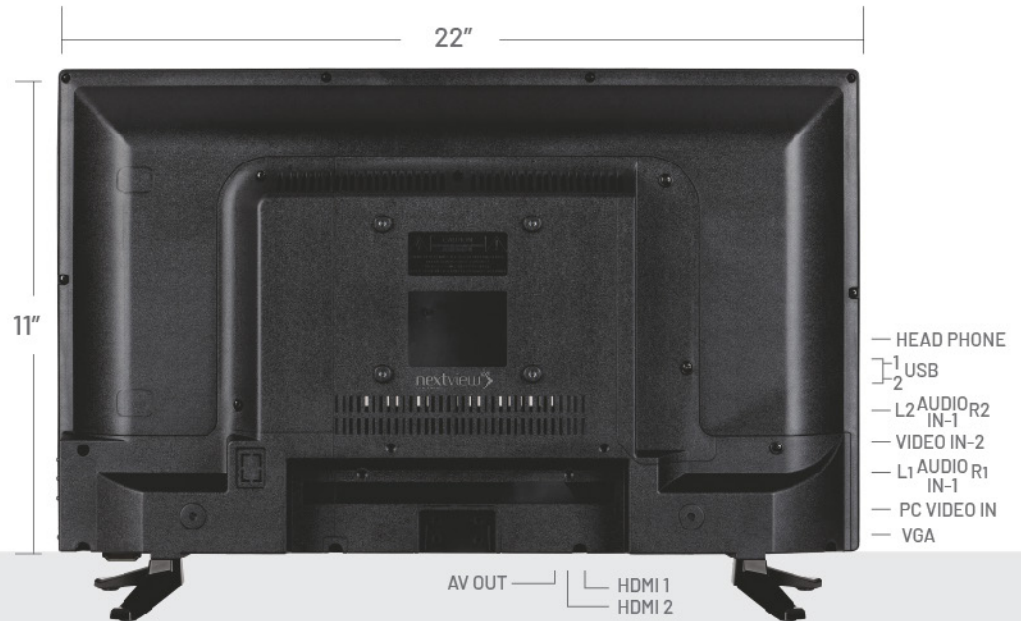

**nextview**  
the vision...





# NV2FH20L



## 20" LED TV

### ARTISTIC DESIGN

Black Border

### ULTIMATE PICTURE QUALITY

1920×1080 | Full HD

### CONNECTIVITY

- HDMI
- USB
- Audio IN & Audio OUT
- AV IN & AV OUT
- VGA / RF

### SUPER SOUND QUALITY

Stereo Sound

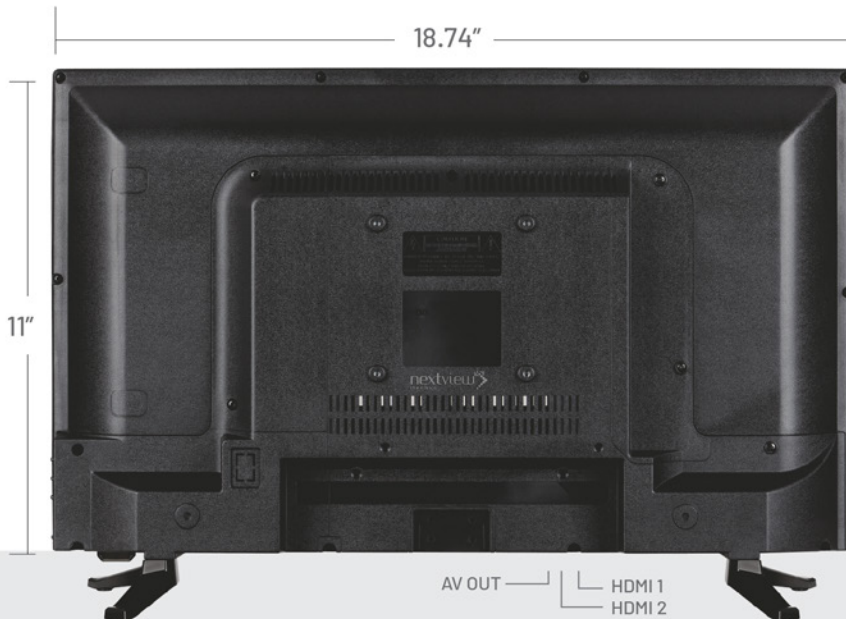

- HEAD PHONE
- 1 USB
- 2 USB
- L2 AUDIO R2 IN-1
- VIDEO IN-2
- L1 AUDIO R1 IN-1
- PC VIDEO IN
- VGA

AV OUT — HDMI 1  
HDMI 2





# UNINTERRUPTED ENTERTAINMENT



## ONSITE TRIPLE PROTECTION

- FIRE • FLUCTUATION • LIGHTING LESS PROTECTION

### HASSLE FREE SERVICES TO CUSTOMER

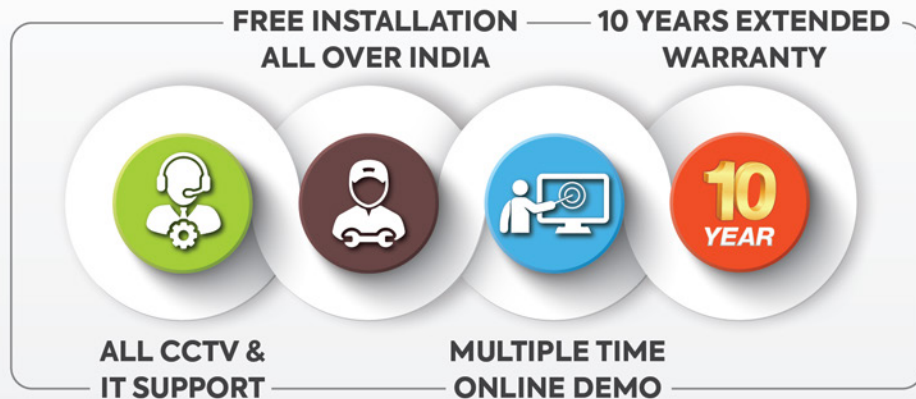

COMPLAIN / INSTALLATION REGISTRATION	1800 2700 139
INSTALLATION UPDATE	+91 97258 23304
COMPLAIN UPDATE	+91 79356 51135 / +91 90160 42507
QUICK HARDWARE SUPPORT	+91 70166 93530
QUICK SOFTWARE SUPPORT	+91 97277 59964
FOR MOTHERBOARD/ BACK LIGHT/ PENAL ETC	+91 96242 47007



**Nextview Technologies (India) Pvt. Ltd.**

 1800 2700 139

 [support@nexttechgroup.com](mailto:support@nexttechgroup.com)



 [www.nexttechgroup.com](http://www.nexttechgroup.com) / [www.nextview.in](http://www.nextview.in)